

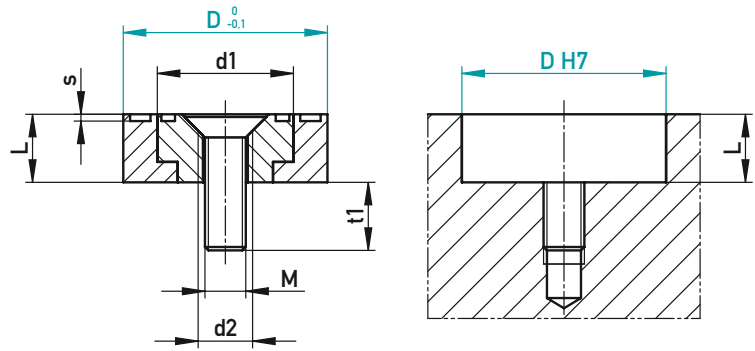

KENNZEICHNUNGSSTEMPEL

MARKING STAMP

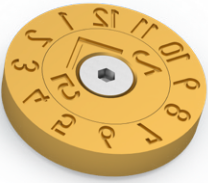

AUF EINEN BLICK

- ▶ Für Schäum- und Tiefziehwerkzeuge
- ▶ Montierbar von vorne
- ▶ Gravur spiegelbildlich vertieft
- ▶ Passender Stelleinsatz 600076



AT A GLANCE

- ▶ For foam and deep-drawing moulds
- ▶ Mountable from the front
- ▶ Engraving inversely recessed
- ▶ Matching insert type 600076

✓ 1x 40033 im Lieferumfang / in scope of delivery

⊞ Messing / Brass MS58

D	Ø 15	Ø 20	Ø 30	Ø 40
L	5	5	5	5
d1	10	13	19	25
s	0,5	0,5	0,5	0,5
M	M3	M3	M4	M5
d2	M4	M4	M5	M6
t1	5	5	5	5

Typ/Type	D				✉
	15	20	30	40	
01  Monate + Jahr Months + Year	•	•	•	•	600504/01/D-Jahr 600504/01/D-Year
02  Monate Months	•	•	•	•	600504/02/D 600504/02/D
03  Jahr + 5 Jahre Year + 5 Years	•	•	•	•	600504/03/D-Jahr 600504/03/D-Year



STELLEINSATZ FÜR 600504W

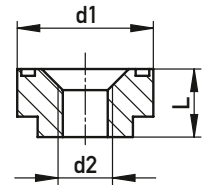

ADJUSTABLE INSERT FOR 600504



✓ 1x 40033 im Lieferumfang / in scope of delivery

⊞ Messing / Brass MS58

D	Ø 15	Ø 20	Ø 30	Ø 40
d1	10	13	19	25
d2	M4	M4	M5	M6
L	4,85	4,85	4,85	4,85

Typ/Type	D				✉
	15	20	30	40	
98  Pfeil Arrow	•	•	•	•	600076/98/D 600076/98/D
99  Pfeil + Jahr Arrow + Year	•	•	•	•	600076/99/D-Jahr 600076/99/D-Year