

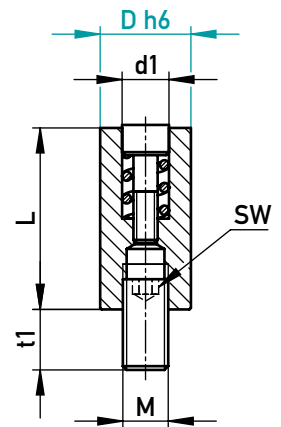

KENNZEICHNUNGSSTEMPEL MARKING STAMP



AUF EINEN BLICK





- Geringe Einbautiefe
- Montierbar von vorne
- Gravur spiegelbildlich vertieft
- Passender Stelleinsatz Typ 600071

AT A GLANCE

- Low installation depth
- Mountable from the front
- Engraving inversely recessed
- Matching insert type 600071

1.4034 / ~56 HRC

D	Ø 4	Ø 5	Ø 6	Ø 8	Ø 10	Ø 12
L	8	12	12	14	16	20
d1	2,1	3,1	3,1	4,4	5,2	6,2
M	M2	M3	M3	M4	M5	M5
SW	0,7	0,9	0,9	1,5	1,5	1,5
t1	3	4	4	6	6	6

Typ/Type	D						✉
	4	5	6	8	10	12	
01  Monate + Jahr Months + Year	•	•	•	•	•	•	600103/01/D-Jahr 600103/01/D-Year
02  Monate Months	•	•	•	•	•	•	600103/02/D 600103/02/D
03  Jahr + 5 Jahre Year + 5 Years	•	•	•	•	•	•	600103/03/D-Jahr 600103/03/D-Year
04  Jahr + 11 Jahre Year + 11 Years	•	•	•	•	•	•	600103/04/D-Jahr 600103/04/D-Year
S  Gravur auf Wunsch Engraving on request	•	•	•	•	•	•	600103/S/D 600103/S/D



KENNZEICHNUNGSSTEMPEL

MARKING STAMP

EINBAURAUUM · MOUNTING SPACE

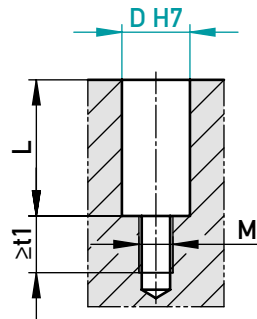

MONTAGEHINWEIS · MOUNTING INSTRUCTION

Montage/Demontage (ohne Stelleinsatz)
Mounting/demounting (without insert)

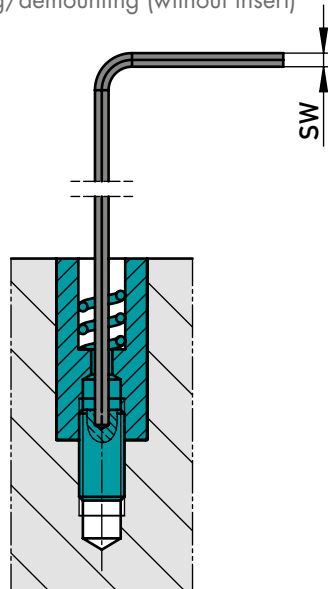

Zusammenbau mit Stelleinsatz
Assembly with adjustable insert

